

Recent advances in the theory of Prescribed Jacobian Equations

Nestor Guillen

UMass Amherst

January 2019

Partially based on past and ongoing works with Jun Kitagawa.

Mappings between distributions

Many different questions in mathematics and applications hinge on the following problem:

Given two probability distributions with densities f and g ,

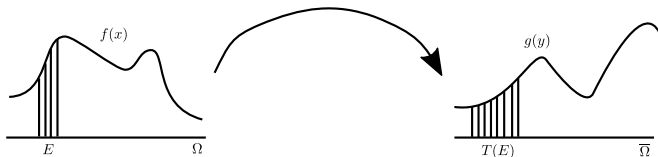

find a mapping $T : \Omega \rightarrow \bar{\Omega}$ that sends f to $g \dots$

$$\text{i.e. } \int_{T(E)} g(y) dy = \int_E f(x) dx \quad \forall E \subset \Omega$$

Mappings between distributions

Many different questions in mathematics and applications hinge on the following problem:

Given two probability distributions with densities f and g ,

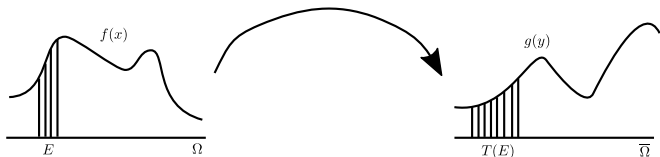

find a mapping $T : \Omega \rightarrow \bar{\Omega}$ that sends f to g where **in addition** the map T is asked to satisfy some **admissibility condition**, e.g. a monotonicity condition or some optimality property (more on this in a second).

Mappings between distributions

If T is differentiable, the change of variables formula gives

$$\int_E f(x) dx = \int_E g(T(x)) \det(DT(x)) dx, \quad \forall E \subset \Omega.$$

Therefore, we get an equation for the **Jacobian** of T

$$\det(DT(x)) = \frac{f(x)}{g(T(x))}.$$

Solving this equation is a way to find the mapping T .

What about the admissibility condition?

Mappings between distributions

The **admissible mappings** T must be of the form

$$T(x) = T_u(x) := \mathcal{F}(x, u(x), Du(x))$$

for a scalar $u : \Omega \rightarrow \mathbb{R}$ and a predetermined $\mathcal{F} : \Omega \times \mathbb{R} \times \mathbb{R}^d \rightarrow \bar{\Omega}$.

With this structure, the problem amounts to finding u solving

$$\det(DT_u(x)) = \frac{f(x)}{g(T_u(x))},$$

Mappings between distributions

The problem

Computing DT_u we arrive at a partial differential equation for u

$$\det(D^2u + \mathcal{A}(x, u, Du)) = \psi(x, u, Du)$$

for some symmetric matrix \mathcal{A} and some positive function ψ .

This is a second order, elliptic, nonlinear PDE.

Problem: To construct smooth solutions to this PDE, under appropriate boundary conditions.

Examples

1. Mappings with convex potentials

The most basic admissibility condition is T being monotone and given by a gradient (a map with a “convex potential”).

A map T is **monotone** if $(T(x_1) - T(x_2), x_1 - x_2) \geq 0$. If a map is monotone and is given by the gradient of a scalar function then this function must be convex.

Examples

1. Mappings with convex potentials

Thus $T(x) = Du(x)$ for some convex function u .

The Jacobian equation is then the Monge-Ampère equation

$$\det(D^2u(x)) = \frac{f(x)}{g(Du(x))}$$

which has been analyzed for over half a century.

Examples

2. Optimal Transportation

We are given a function $c : \Omega \times \bar{\Omega} \rightarrow \mathbb{R}$ representing a **cost**.

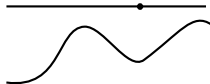
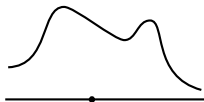

Namely, moving m units of mass from x to y costs $mc(x, y)$.

Monge's Optimal Transport Problem

Among all mappings sending f to g , minimize the **total cost**

$$\int_{\Omega} c(x, T(x)) f(x) dx$$

Examples

2.Optimal Transportation

The “Quadratic Euclidean Cost”, $c(x, y) = |x - y|^2$.

This cost arises in fluid mechanics, meteorology, probability, and machine learning (keyword: Wasserstein distance).

The respective OT problem is equivalent to that maximizing

$$\mathbb{E}[X \cdot Y]$$

i.e. for random vars X, Y what relation maximizes $\text{Cov}(X, Y)$?

Examples

2.Optimal Transportation

Theorem (Brennier 1992 and Gangbo-McCann 1996):
There is a unique optimal mapping T . It satisfies the equation

$$(D_x c)(x, T(x)) = Du(x)$$

for some scalar u enveloped by the cost function as follows

$$u(x) = \max_{y \in \bar{\Omega}} \{-c(x, y) + v(y)\},$$

for some $v : \bar{\Omega} \rightarrow \mathbb{R}$.

Examples

2.Optimal Transportation

If $(D_x c)(x, \cdot)$ has an inverse $\mathcal{F}(x, \cdot)$, then

$$(D_x c)(x, T(x)) = Du(x) \Leftrightarrow T(x) = \mathcal{F}(x, \nabla u(x)).$$

When $c(x, y) = d_g(x, y)^2$, with d_g the geodesic distance w.r.t. to a Riemannian metric g , the above reduces to

$$T(x) = \exp_x(\nabla u(x))$$

Examples

2.Optimal Transportation

Differentiating the equation

$$(D_x c)(x, T(x)) = Du(x)$$

we see that the Jacobian equation takes the form

$$\det(D^2u + \mathcal{A}(x, Du)) = \psi(x, Du).$$

This is sometimes called the c -Monge-Ampère equation.

Examples

3. Near-Field Reflector Problems

A distribution of collimated light beams is shot upwards, the intensity of the light emanating from x is given by $f(x)$

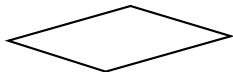
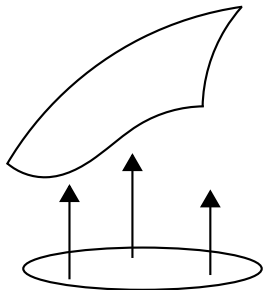

Examples

3.Near-Field Reflector Problems

The beams reflect on an unknown surface Σ , and hit the ground.

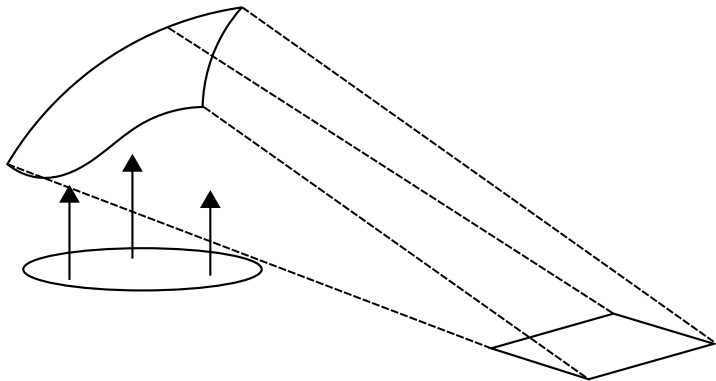

The reflection happens according to Snell's law.

Examples

3. Near-Field Reflector Problems

The intensity of the light hitting a point y is given by $g(y)$, representing the shape projected on the ground

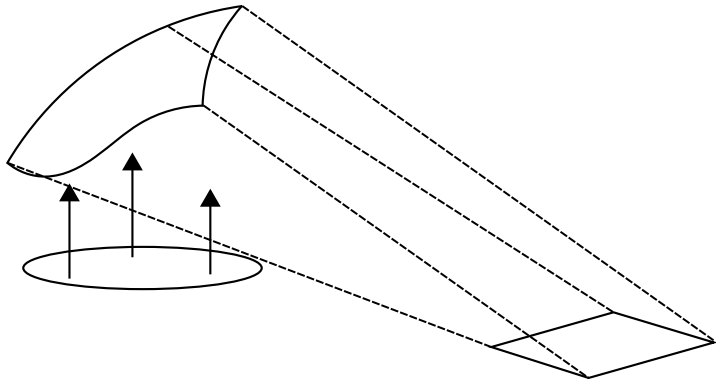

Reflector Problem: given f and g determine Σ .

Examples

3. Near-Field Reflector Problems

To make the problem well posed, we ask Σ is the graph of a function u which is an envelope of paraboloids

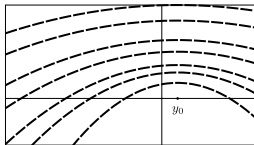

That is, u is a minimum of functions of the form

$$G(x, y, z) = \frac{1}{4z} - z|x - y|^2$$

Such a paraboloid sends all light beams to the point y_0 .

Examples

3. Near-Field Reflector Problems

A simple computation shows that the light at x reaches $y = T(x)$, given by

$$T(x) = x + \frac{2uD u}{(1 - |D u|^2)}$$

The resulting equation is

$$\det \left(D^2 u + \frac{(1 - |D u|^2)}{2u} \text{Id} \right) = \frac{1}{(2u)^n} \frac{(1 - |D u|^2)^{d+1}}{(1 + |D u|^2)} \frac{f(x)}{g(T(x))}.$$

Examples

Prescribed Jacobian Structure

In summary, all these examples have the following in common:

1. **A gradient structure.**
2. **A convexity condition.**

These are aspects of one object, a **Generating Function**.

These objects and their respective Jacobian equations have been studied for decades, but it was only in 2014 when **Trudinger** named them and set them up within a broad and consistent framework.

Elements Of Generating Functions

A **Generating Function** is a smooth function

$$G : \Omega \times \bar{\Omega} \times \mathbb{R} \rightarrow \mathbb{R},$$

which, first, is strictly increasing in the third argument:

$$G(x, y, z) < G(x, y, z') \text{ if } z < z'.$$

Elements Of Generating Functions

The exponential

Second, G is assumed to satisfy a **Nondegeneracy property**:

Fix $x \in \Omega$. Then for each p and u , the system of equations

$$(D_x G)(x, y, z) = p, \quad G(x, y, z) = u$$

has a unique solution (y, z) , moreover the dependence of (y, z) on (p, u) is differentiable.

Elements Of Generating Functions

The exponential

This defines a smooth map

$$\exp_{x,u} : D_{x,u} \subset \mathbb{R}^d \rightarrow \bar{\Omega},$$

which is known as the ***G*-exponential map**.

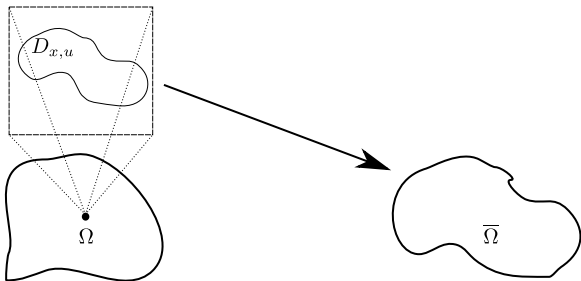

Elements Of Generating Functions

The exponential

Likewise we have a map

$$\exp_{y,z} : D_{y,z} \subset \mathbb{R}^d \rightarrow \Omega.$$

which is also referred to as the ***G*-exponential map**.

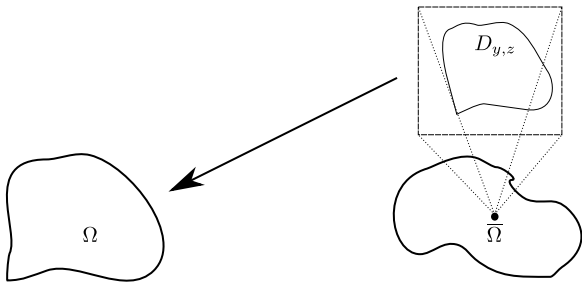

Elements Of Generating Functions

The exponential and G -segments

A curve $y(s)$ is said to be a G -**segment** with respect to (x, u) if

$$y(s) = \exp_{x,u}^G(sv_0 + (1-s)v_1)$$

In other words G -segments are curves that look like **straight lines** under the **exponential map**.

Elements Of Generating Functions

The examples revisited

Classical convex analysis:

$$G(x, y, z) = x \cdot y - z$$

Optimal transport

$$G(x, y, z) = -c(x, y) - z$$

Parallel beam reflector

$$G(x, y, z) = \frac{1}{4z} - z|x - y|^2$$

Elements Of Generating Functions

The Prescribed Jacobian Equation

Now, revisiting our admissibility condition, the types of mappings we are looking are those of the form

$$Tu(x) = \exp_{x,u(x)}^G(Du(x))$$

for some scalar u and some Generating Function u .

Elements Of Generating Functions

The Prescribed Jacobian Equation

The Jacobian equation takes the general form,

$$\det(D^2u + A(x, u, Du)) = \psi(x, u, Du)$$

where A and ψ depend are computed from $\exp_{x,u}^G$.

This is called a **Generated Jacobian Equation (GJE)**.

Elements Of Generating Functions

G-convex functions

The function u cannot be any scalar function. It must be **G-convex**, that is, its graph must be of the form



$$\begin{aligned}u(x) &\geq G(x, y_0, z_0), \quad \forall x \in \Omega, \\u(x_0) &= G(x_0, y_0, z_0).\end{aligned}$$

We say y_0 is **supporting to u at x_0** .

Elements Of Generating Functions

We now define the **subdifferential** of a G -convex function

$$\partial_G u(x_0) = \{y \in \bar{\Omega} \mid G(\cdot, y, z) \text{ is supporting to } u \text{ at } x_0\}.$$

This is a multivalued map from Ω to $\bar{\Omega}$.

For a set E , we also consider its image under $\partial_G u(E)$

$$\partial_G u(E) = \bigcup_{x \in E} \partial_G u(x)$$

Elements Of Generating Functions

Finally, note that if u is smooth, $\partial_G u(x)$ has a single element (i.e. it is single-valued) and is given by

$$\exp_{x,u(x)}^G(Du(x)).$$

The key thing is that $\partial_G u(x)$ is always well defined for a G -convex function, even those which are not smooth.

Now we can revisit our main problem.

Elements Of Generating Functions

The main problem, revisited:

Find a map T sending f to g , where T is given in terms of a G -convex function as just described.

Weak formulation:

A G -convex function is a **weak solution** of the GJE if

$$\int_{\partial_G u(E)} g(y) dy = \int_E f(x) dx, \quad \forall E \subset \Omega.$$

We emphasize that in this case the associated “mapping” T_u is a priori not even a function! (it is potentially multivalued).

Elements Of Generating Functions

Theorem (Brenier, Gangbo-McCann, Trudinger)

There is always a weak solution!

The main problem, reformulated:

To determine, for a given G and densities f and g , whether a weak solution u is smooth.

Main result

Tilting of G -functions

Fix x_0, u_0 and a G -segment $y(t)$ respect to them, define

$$m_t(x) = G(x, y(t), z(t)).$$

where $z(t)$ is chosen so that $G(x_0, y(t), z(t)) = u_0$, thusly:

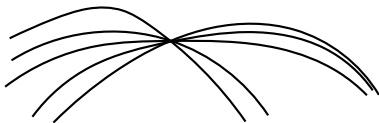

In words: m_t is a family of G -functions with “focus” y moving along a G -segment and such that $m_t(x_0) = u_0$.

Main result

Assumptions

Property Q: There is some $M \geq 1$ such that for any $x \in S$

$$f(t) - f(0) \leq Mt(f(1) - f(0))_+, \quad \forall t \in [0, 1].$$

Graphs of:

$$f(0) + Mt(f(1) - f(0))$$

$$f(0) + t(f(1) - f(0))$$

$$f(t)$$

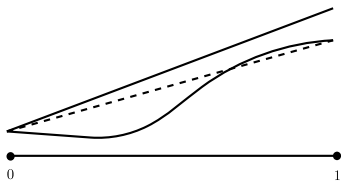

where with m_t as before we have set $f(t) := m_t(x)$.

Main result

Theorem (Guillen-Kitagawa, 2017)

Let G satisfy the Q -condition, and

$$\lambda \leq f, g \leq \Lambda \text{ in } \Omega, \bar{\Omega}.$$

Then, for any weak solution u :

- *The function u is $C_{\text{loc}}^{1,\alpha}(\Omega)$ for some α .*
- *The G -gradient map of u is Hölder continuous.*
- *The G -gradient map of u is injective.*

Moreover, the estimates only depend on G , M , Λ , and λ .

Main result

Consequences

A first Corollary of this result is the smoothness of the reflecting surface for near field reflector problems.

Theorem

The solutions to the parallel and point-source near field reflector problems are smooth surfaces given by the graphs of $C^{1,\alpha}$ functions.

Main result

Consequences

The result also gives a new proof of an important theorem in the theory of optimal transportation.

Theorem (Figalli-Kim-McCann '13, Guillen-Kitagawa '15)

For costs satisfying the A3 condition of Ma-Trudinger-Wang, the unique (weak) optimal transport map is Hölder continuous and injective.

Previous results

A very partial timeline

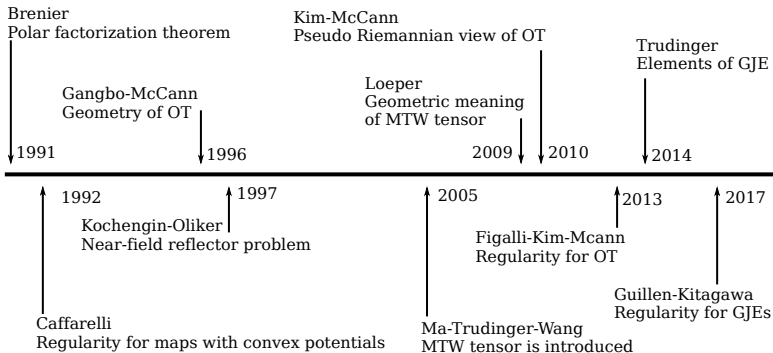

Previous results

Results dealing with $\det(D^2u)$

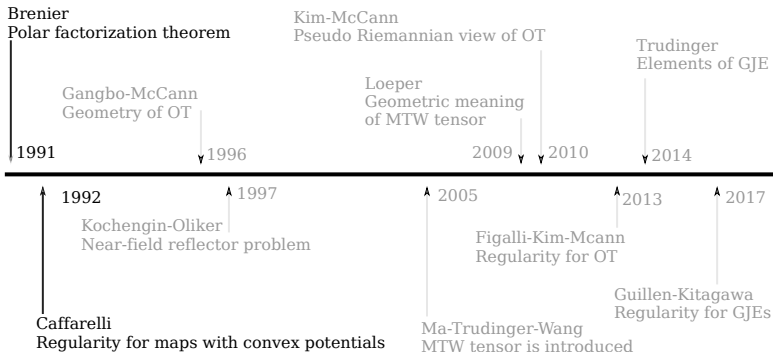

Previous results

Results dealing with $\det(D^2u + A(x, Du))$

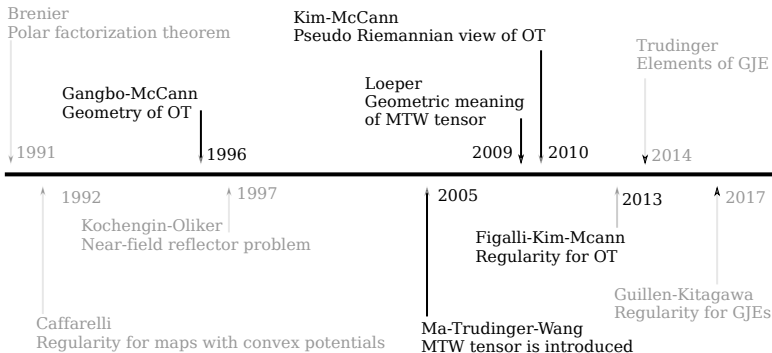

Previous results

Results dealing with $\det(D^2u + A(x, u, Du))$

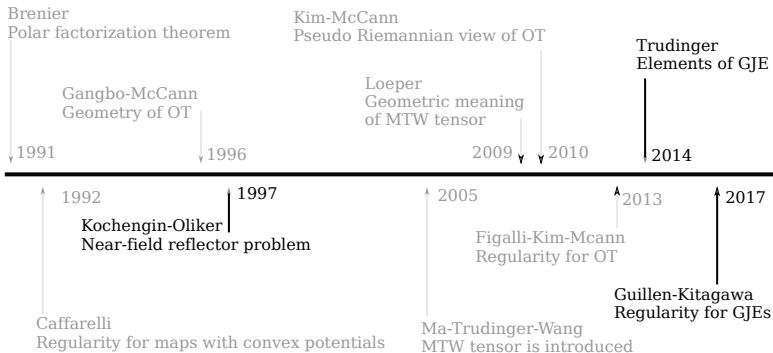

Strategy

Sections of u

The approach is based on studying certain “level sets” of u .

If $G(\cdot, y_0, z_0)$ touches u from below at x_0 , define for $h > 0$

$$S_h = \{u(x) \leq G(x, y_0, z_h)\}.$$

With z_h chosen so that $G(x_0, y_0, z_h) = G(x_0, y_0, z_0) + h$.

If $G(x, y_0, z_0)$ supports u at x_0 , S_h is called a **section** of u .

Strategy

How “round” is S_h ? It depends on $\partial_G u(S_h)$!

Let us consider the graphs of three convex functions



How large is $\partial u(S)$ in each case?

The key geometric fact:

$$\text{larger } h \Rightarrow \text{larger } |S| \text{ or larger } |\partial_G u(S)|$$

Strategy

The main tool in the proof

Theorem (Guillen-Kitawa)

The following estimate holds for any $x \in S$,

$$(G(x, y_0, z_0) - u(x))^d \leq C d_{\text{aff}}(x, \partial S) |S| |\partial_G u(S)|.$$

Moreover,

$$\sup_x (G(x, y_0, z_0) - u(x))^d \geq C |S| |\partial_G u(\frac{1}{2}S)|.$$

These are known as **Aleksandrov type** estimates, as they generalized an estimate of Aleksandrov for classical convex function.

Strategy

Pointwise estimates combined \Rightarrow graph of u can't peak near ∂S .

Corollary

The function u is differentiable in the interior of Ω .

Strategy

A quantitative version of the argument yields $C^{1,\alpha}$ estimates.

Corollary

The function u is $C^{1,\alpha}$ in the interior of Ω , moreover

$$\|Du\|_{C^\alpha(\Omega')} \leq C(G, \bar{\Omega}, \Omega', \Omega, \lambda, \Lambda)$$

the constant α being determined from G , Λ , and λ .

Strategy

Why do the Aleksandrov-type pointwise estimates hold?!

$$\left. \begin{array}{l} \text{Proving the inequality } \dots \\ h^d \leq C|S| |\partial_G u(S)| \end{array} \right\} \iff \left\{ \begin{array}{l} \dots \text{ amounts to proving} \\ \exists A \subset \partial_G u(S) \\ \text{s.t. } |A| \geq C \frac{h^d}{|S|}. \end{array} \right.$$

This is precisely where the Q -property comes in.

Strategy

$$S^* := \left\{ y \in \bar{\Omega} : \begin{array}{l} G(x_0, y, z_y) = u(x_0), \text{ for some } z_y \\ G(x, y, z_y) \leq G(x, y_0, z_h) \forall x \in S \end{array} \right\}$$

It is not difficult to see that

$$S^* \subset \partial_G u(S).$$

Strategy

Fix $x \in S$. Let $y(t)$ be a G -segment w.r.t. (x_0, u_0) with

$$y(0) = y_0, \quad y(1) = y_1 \in \partial B_r(y_0).$$

By the Q -property, we have

$$G(x, y(t), z(t)) - G(x, y_0, z_0) \leq Mt (G(x, y_1, z_1) - G(x, y_0, z_0))$$

We have $y(t) \in S$ if the LHS is $\leq ch$ for all x , so

$$y(t) \in S \text{ for } t \lesssim \frac{h}{\sup_x \{G(x, y_1, z_1) - G(x, y_0, z_0)\}}$$

Strategy

Since

$$\sup_x \{G(x, y_1, z_1) - G(x, y_0, z_0)\} \leq Cd(x_0, \Pi)$$

it follows S contains a G -segment of length at least

$$\frac{c_0 h}{d(x_0, \Pi)}$$

in the direction from y_0 to y_1 .

Future works

1. Minkowski problem in Riemannian manifolds.
2. Optimal partitions using Wasserstein distance.
3. Optimal transport methods in redistricting and political geography.
4. For more on background of GJE and other applications, see forthcoming *Notices of the AMS* survey **later this year**.



Thank You!

Questions and comments welcome!
nguillen@math.umass.edu